

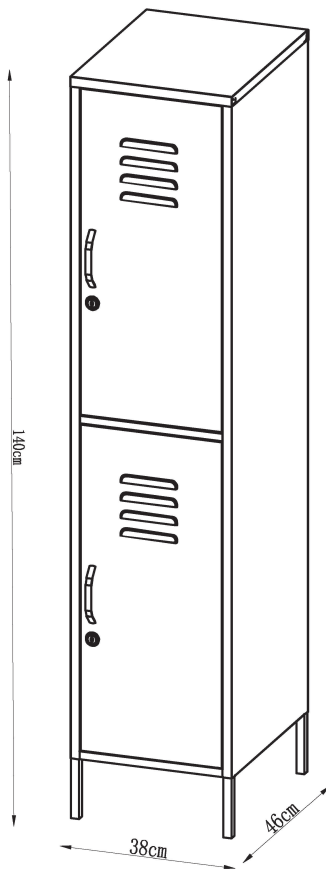



Campus 2 Tier Locker



INSTRUCTION MANUAL

Maximum Weight for this product is 40kgs

Assembly Details

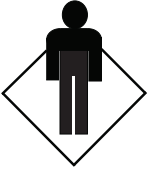
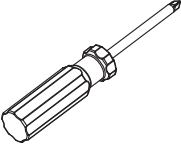
<p>Time: 10 MIN</p> <p>APPROXIMATE ASSEMBLY</p>	<p>1 PERSON ASSEMBLY</p> 	<p>FLOOR AREA 1.5Mx1.5M</p>  <p>REQUIRED ASSEMBLY SPACE</p>
 <p>REQUIRED ASSEMBLY TOOLS</p>		









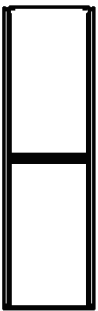

Tips before you start

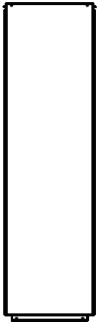
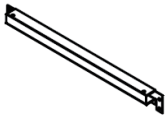
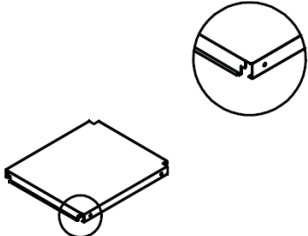
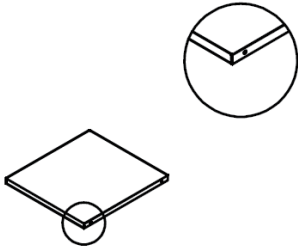
- 1 For the protection of your furniture, we recommend that the product is placed on a protected surface during assembly to prevent any damage
- 2 Please check that all parts are present before you start the assembly of your furniture.
- 3 For ease and speed of assembly, we recommend that you identify all the parts required for each step before commencing with assembly.
- 4 For larger items, please ensure that you have sufficient space and people (as indicated on page 1) to assemble your product safely.
- 5 We recommend that, where possible, all items are assembled near to the area in which they will be placed in use, to avoid moving the product unnecessarily.
- 6 During assembly please take care not to over-tighten hardware, as this may damage the product. Do not use power tools.
- 7 Always place the product on a steady and stable surface.
- 8 Do not stand on the product. Do not use the product as a stepladder.
- 9 This product is intended for indoor, household use only as it is a non-industrial product.
- 10 Please use caution and care when lifting the product to avoid personal injury and/or product damage.

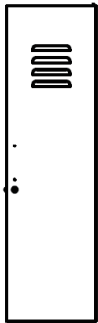
Care and maintenance

- ✓ Please periodically check all things and re-tighten as necessary.
- ✓ To clean your item, please use a damp cloth and wipe clean.
- ✓ Never allow any kind of liquid to remain on your furniture.
- ✓ Absorption can cause wood to warp or finishes to de-laminate.
- ✓ Please do not place hot items (eg. Hot drinks) directly on to the surface.
- ✓ Please do not drag and pull your furniture.

Part Name

<p>A</p>  <p>2PCS</p>	<p>B</p>  <p>2PCS</p>	<p>C</p>  <p>1PC</p>		
<p>D</p>  <p>1PC</p>	<p>E</p>  <p>1PC</p>	<p>F</p>  <p>3PCS</p>		
<p>G</p>  <p>1PC</p>	<p>H</p>  <p>2PCS</p>	<p>I</p>  <p>2PCS</p>		
<p>J</p>  <p>8PCS</p>	<p>K</p>  <p>2PCS</p>	<p>L</p>  <p>4PCS</p>	<p>M</p>  <p>2PCS</p>	<p>N</p>  <p>4PCS</p>

Assembly

STEP 1

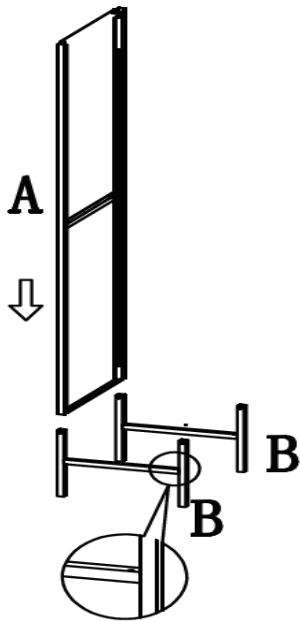

STEP 2

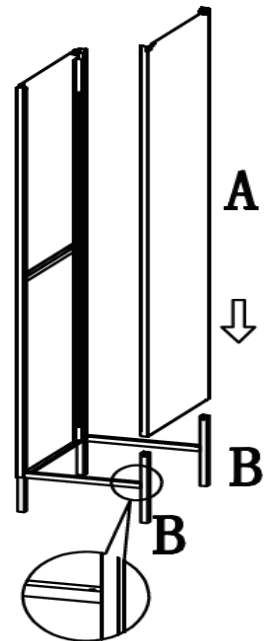

STEP 3

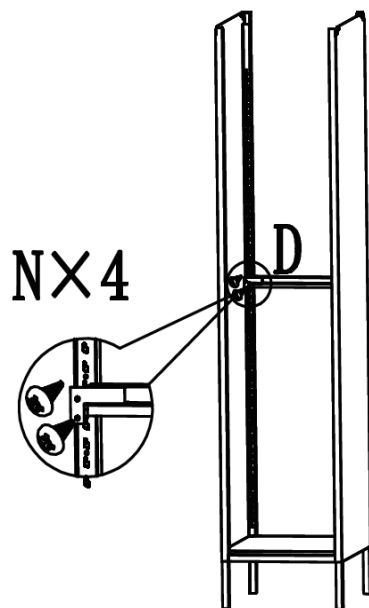

STEP 4

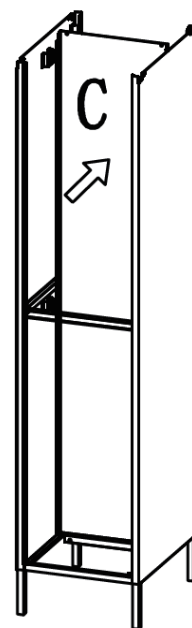

Assembly

STEP 5

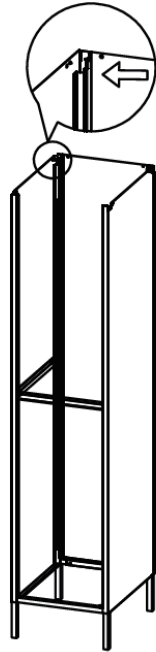

STEP 6

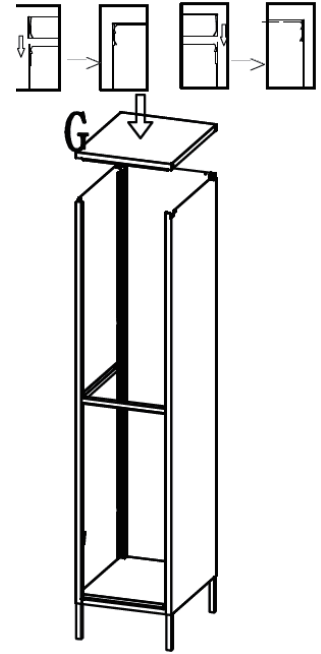

STEP 7



STEP 8

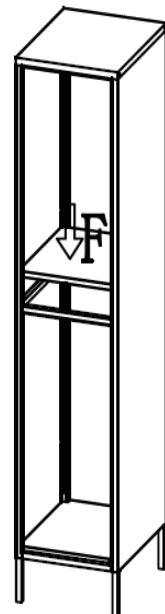

Assembly

STEP 9

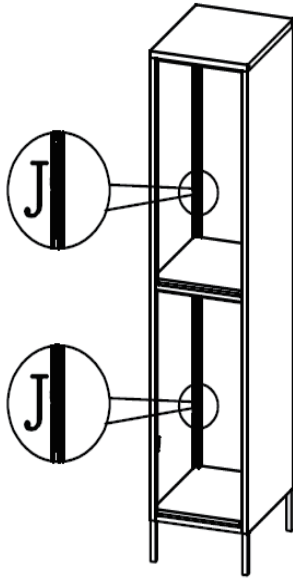

STEP 10

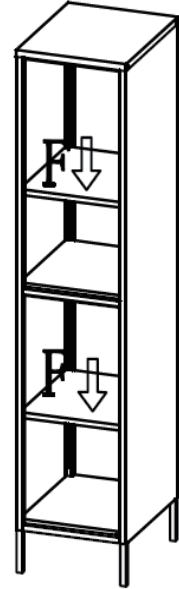

STEP 11

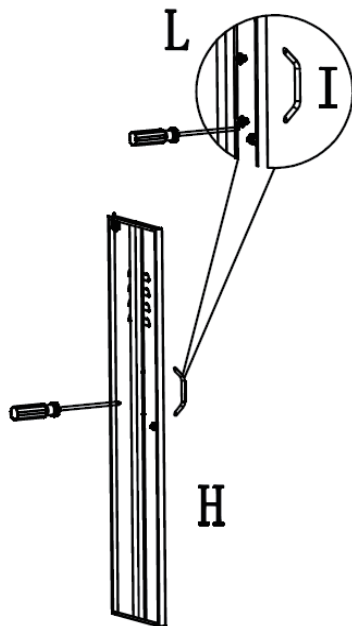

STEP 12

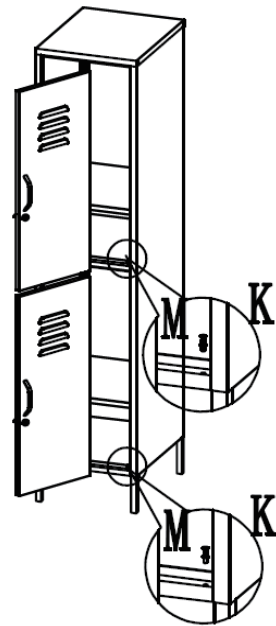



**WORK
SPACE**®

Warranty

We pride ourselves on producing a range of quality home appliances that are both packed with features and completely reliable. We are so confident in our products, we back them up with 1-year warranty. Now you too can relax knowing that you are covered.

Customer Helpline NZ: 0800 222 246
This Product is covered by 1-year warranty
when accompanied by proof of purchase.