

living & co.

NEO CHAIR

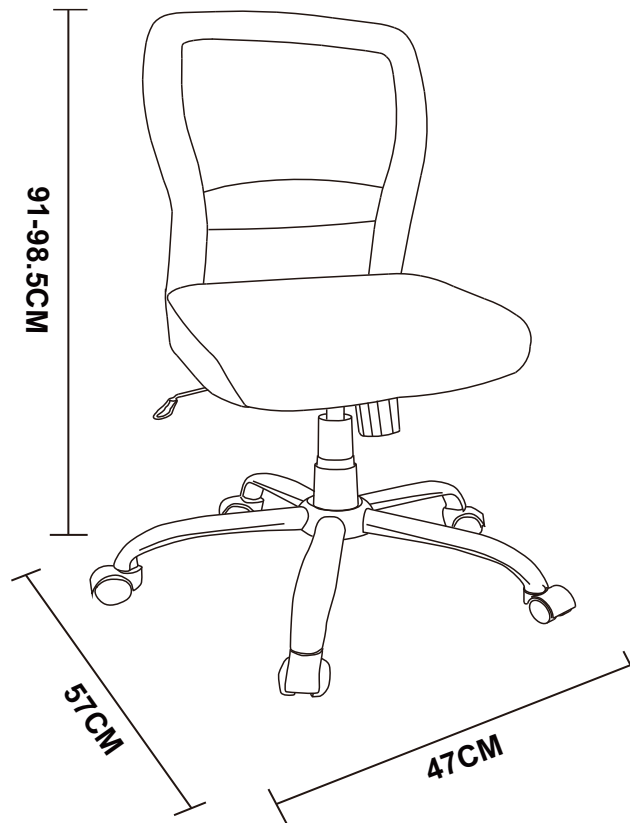



INSTRUCTION MANUAL

Maximum weight for this product is 120kgs

AFTER SALES SUPPORT

  0800 422 274

Assembly Details

<p>10 mins</p> <p>Approximate Assembly Time</p>	<p></p> <p>1 person assembly</p>	<p>Floor Area: 1.5*1.5 meters</p> <p>Required Assembly Space </p>
--	---	---



Tips Before you Start

1. Please check that all parts are present before you start the assembly of your furniture.
2. For ease and speed of assembly, we recommend that before you commence each step of the assembly, that you identify all the parts required for that step.
3. For larger items, please ensure that you have sufficient space and people (as indicated on page 1) to assemble your product safely.
4. We recommend that, where possible, all items are assembled near to the area in which they will be placed in use, to avoid moving the product unnecessarily once assembled.
5. For the protection of your furniture, we recommend that the product is placed on a protected surface during assembly to prevent any damage.
6. During assembly please take care not to over-tighten any fittings, as this may damage the product.
7. Always place the product on a flat, steady and stable surface.
8. Do not stand on the product. Do not use the product as a stepladder.
9. This product is intended for indoor, household use only as it is non industrial product.
10. Put all hardware into their allocated holes before tightening them with the allen key supplied.



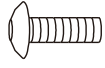
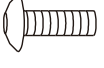

Care and Maintenance

- Upon completion of assembly be sure that all screws, bolts and fastening devices have been tightened securely. Frequent periodic inspection should be made of all hardware and tightened if needed. Inspect the chair to check if any parts are missing or broken.
- The chair can be cleaned by wiping with a damp cloth and drying with a soft dry cloth.
- Never clean with abrasive ammonia base, bleach base or spirit type cleaners.
- If refinishing, use a non-toxic finish only for children's products.
- Use only replacement parts supplied by manufacturer.

Hardware List

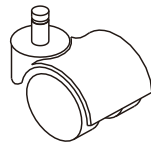
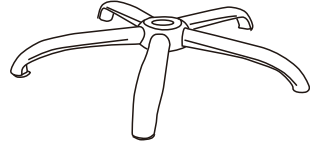
<p>H</p> <p>M6×25mm</p>  <p>6PCS</p>	<p>I</p> <p>M6×20mm</p>  <p>2PCS</p>	<p>J</p> <p>M5</p>  <p>1PC</p>
--	--	---

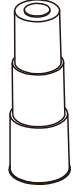
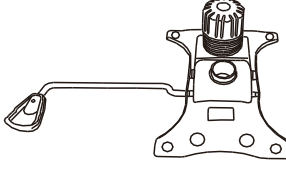

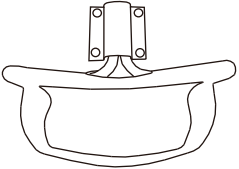
Parts List

<p>A</p>  <p>5PCS</p>	<p>B</p>  <p>1PC</p>
<p>C</p>  <p>1PC</p>	<p>D</p>  <p>1PC</p>
<p>E</p>  <p>1PC</p>	<p>F</p>  <p>1PC</p>
<p>G</p> 	

Assembly

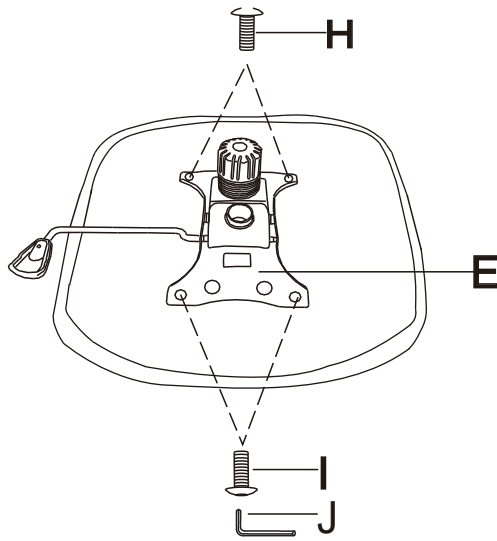

STEP 1

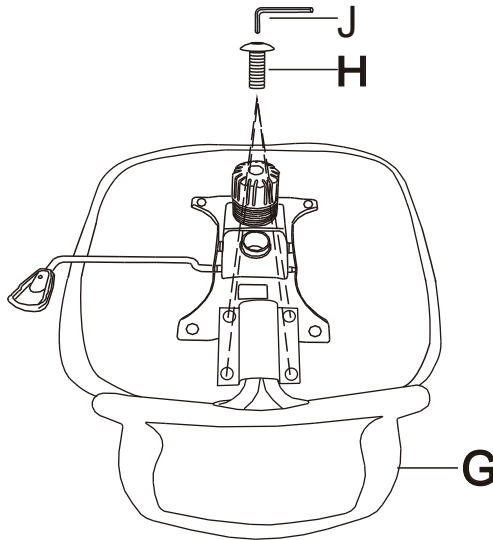

<p>I M6×20mm</p>  <p>2PCS</p>	<p>H M6×25mm</p>  <p>2PC</p>	<p>J M5</p>  <p>1PC</p>
--	---	--

STEP 2

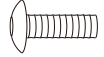

<p>H M6×25mm</p>  <p>4PC</p>	<p>J M5</p>  <p>1PC</p>
---	--

Assembly

STEP 4

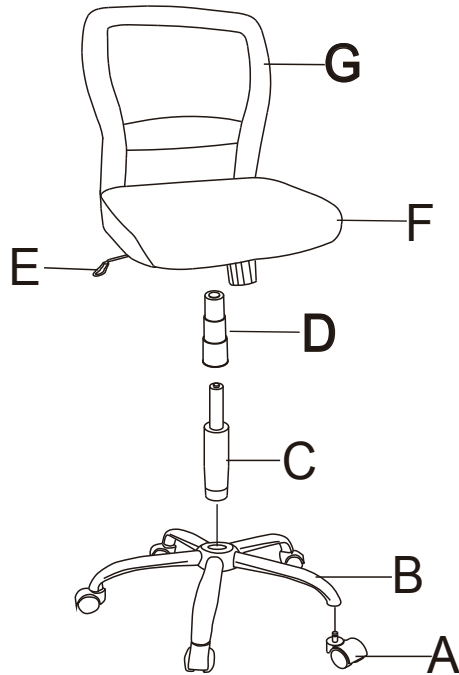

STEP 5

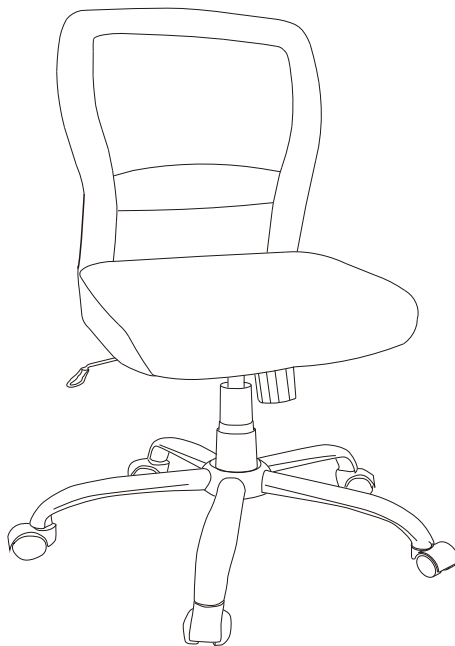



living & co.

Warranty

We pride ourselves on producing a range of quality products that are both packed with features and completely reliable. We are so confident in our products, we back them up with a one-year warranty.

Now you too can relax knowing that you are covered.

Customer Helpline NZ: 0800 422 274

This product is covered by 1 year warranty when accompanied by proof of purchase.

AFTER SALES SUPPORT

 **NZ** 0800 422 274