

# Chrome Trolley

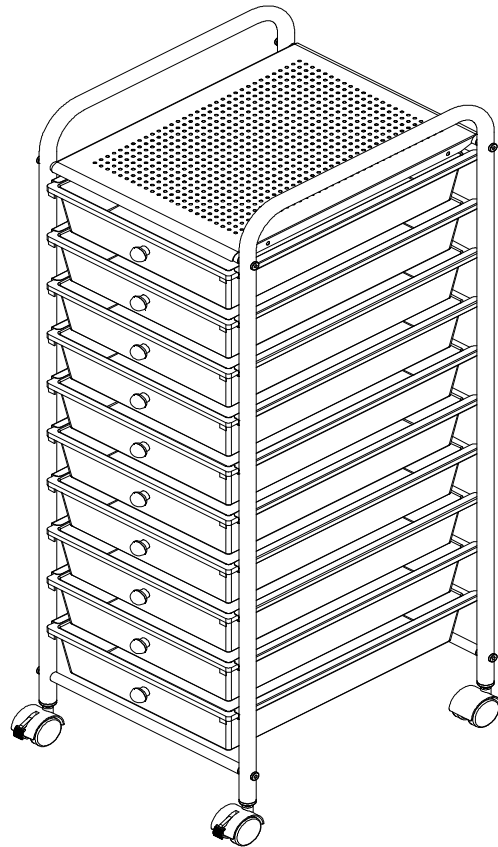

## JTAIC

## Chrome Trolley 10 Drawer Brights

**Please follow these Assembly Instructions.**

This will save you time, make assembly easier and prevent possible damage to your new Hutch. Assistance may be required for some assembly procedures. Correct assembly is your responsibility.

We recommend that the unit is assembled on a soft surface such as carpet.

Please record your serial number in the space provided below and retain this manual for future reference.

Serial No







**1**  
YEAR

WARRANTY

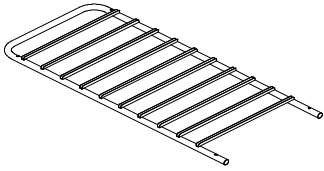
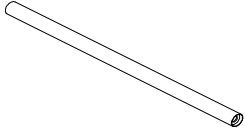
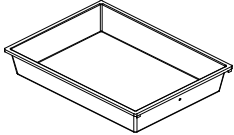
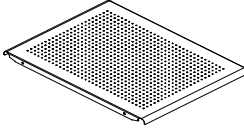
For warranty registration and information please go to  
[www.jasperj.co.nz](http://www.jasperj.co.nz)

  
JASPER J

# Pack Contents

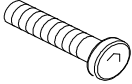
A		2
B		4
C		10
D		1
E		1
F		10
G		10
H		4
I		2
J		2
K		8

## Customer Service

0800 450 314

To request spare parts, please provide the details in step one - six.

1. Model number of unit purchased
2. Proof of purchase
3. Description of missing part
4. Part number of missing part
5. Quantity of missing part
6. Serial number of the unit



Post request to.

OR

Scan and take photos  
of any damaged parts



Before requesting spare parts, please ensure that you have checked your packaging and used the correct hardware at each step.

JasperJ helpdesk  
P.O. Box 47130,  
Ponsonby  
Auckland 1144

customerservice@jasperj.co.nz

# Step 1

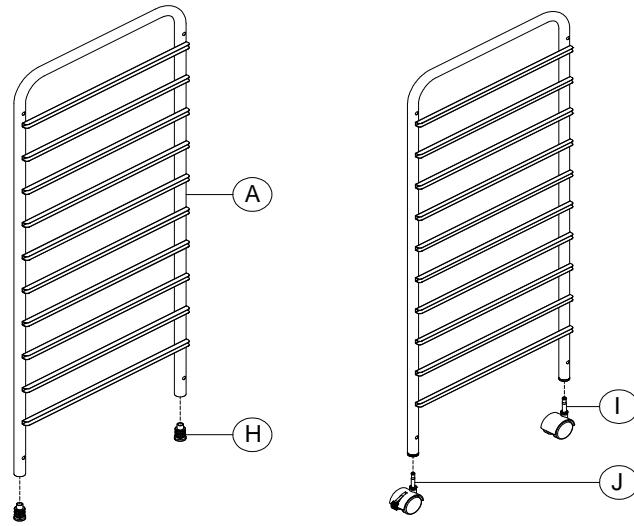

# Step 2

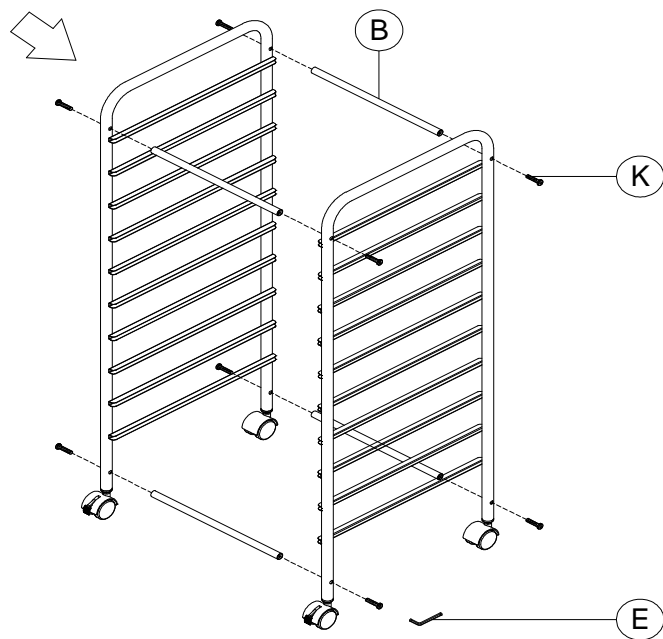
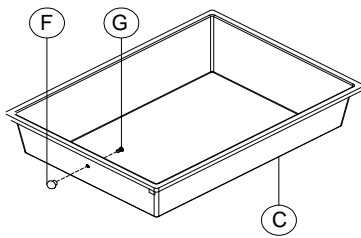

# Step 3

