

Cubit Cupboard (1800mm High)

Assembly Instructions

Tools Required: Powered screwdriver.

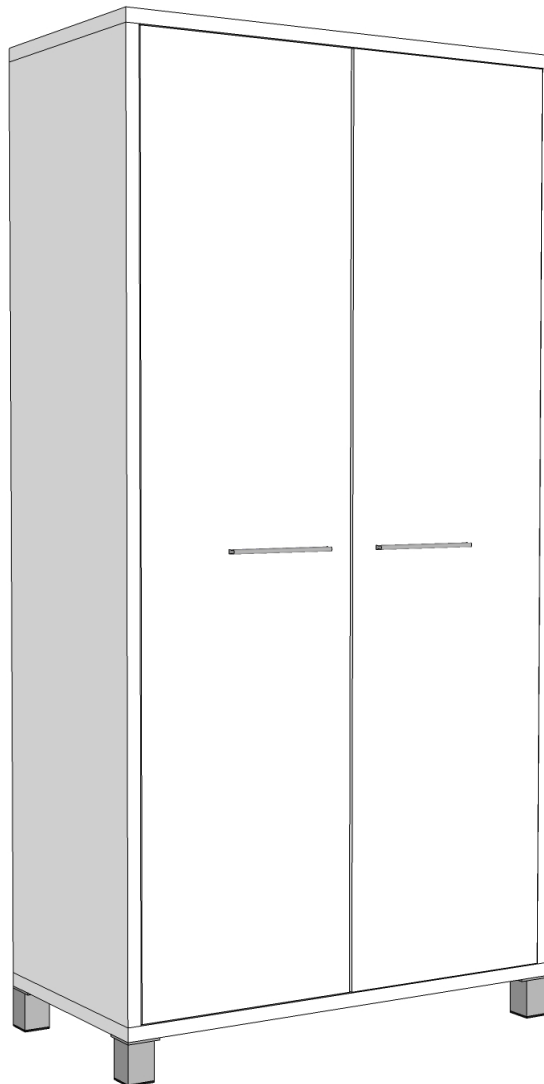

Assembly Instructions

· To prevent possible scratches or damage, assemble the cupboard on a soft surface such as a blanket, carpet or packaging.

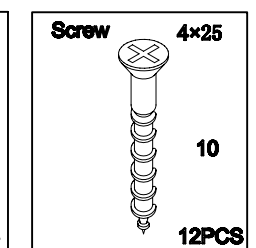
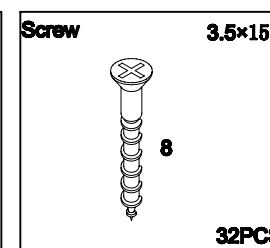
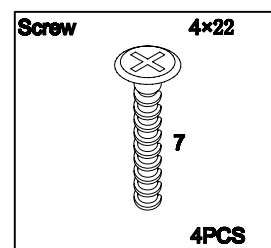
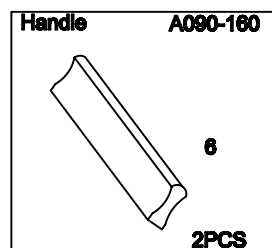
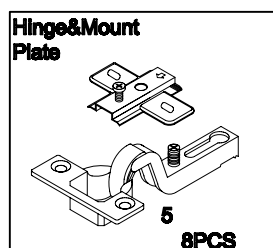
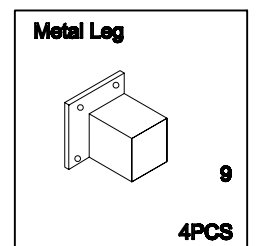
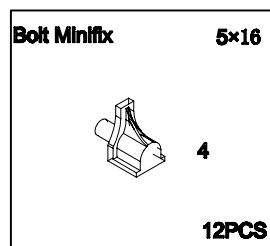
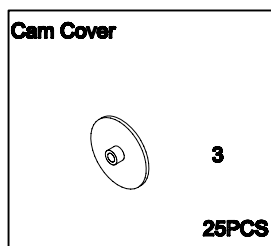
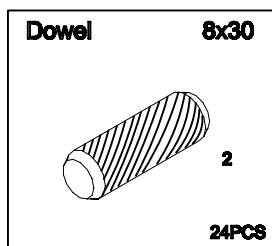
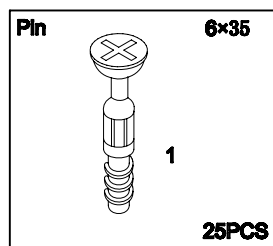
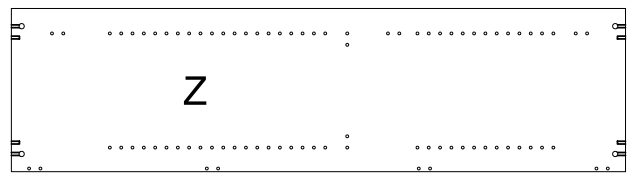
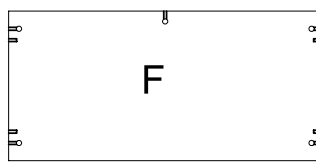
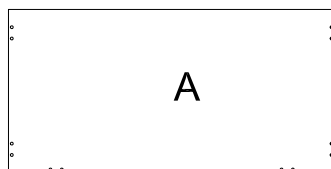
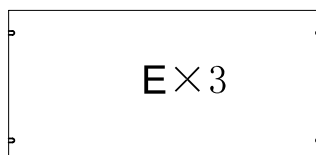
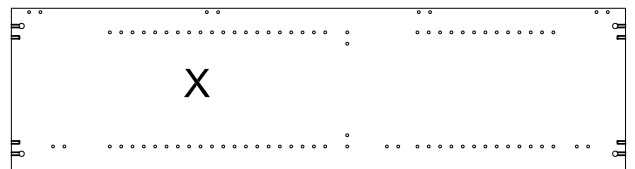
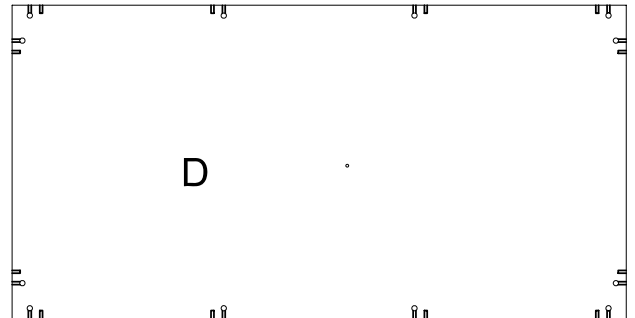
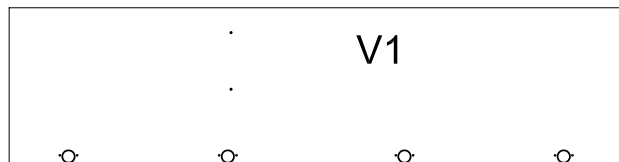
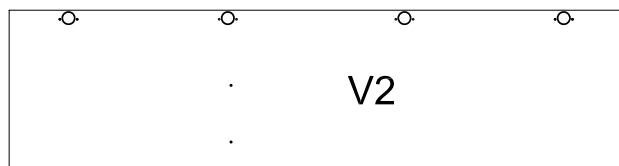

Assembly Instructions

Step 1

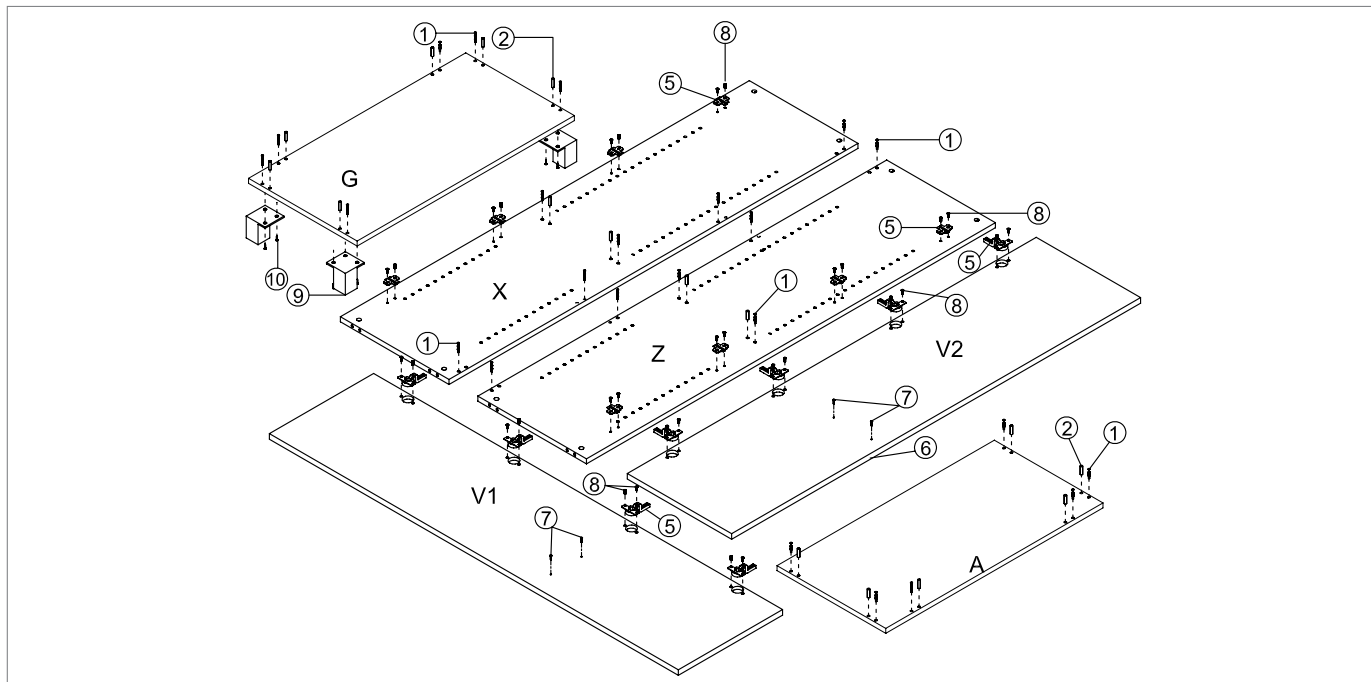

Step 2

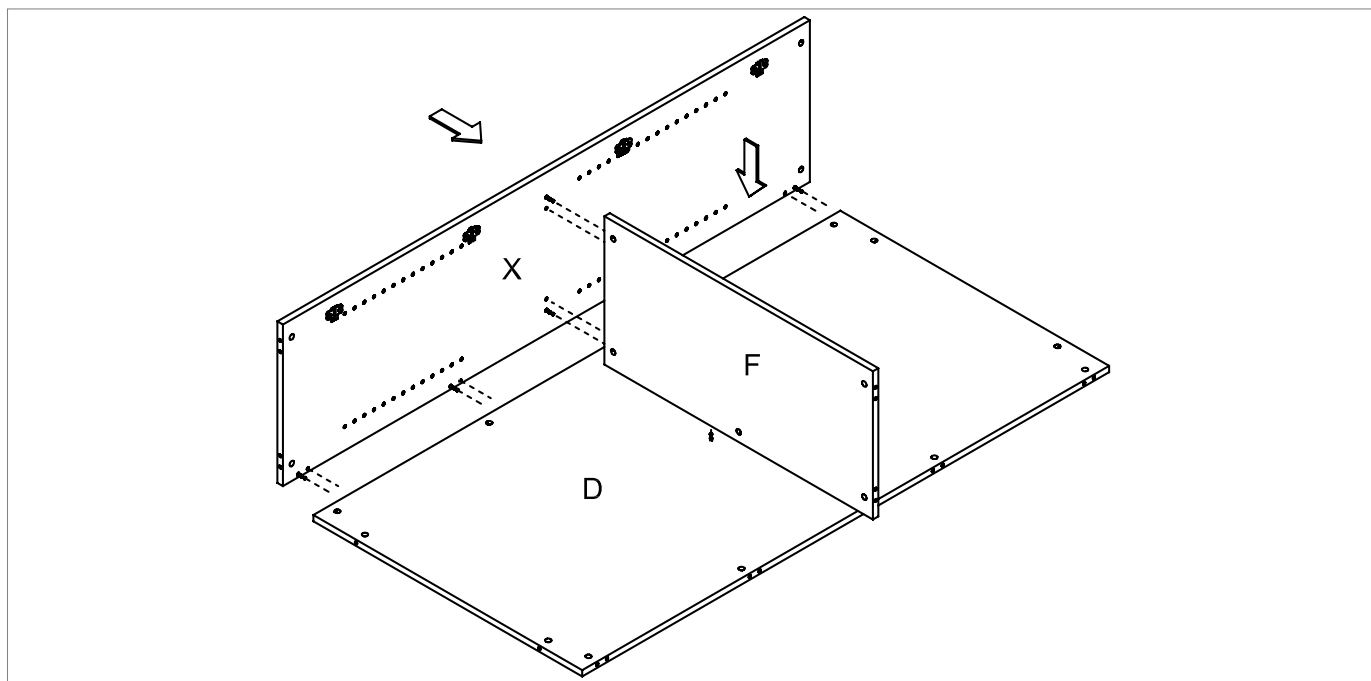

Assembly Instructions

Step 3

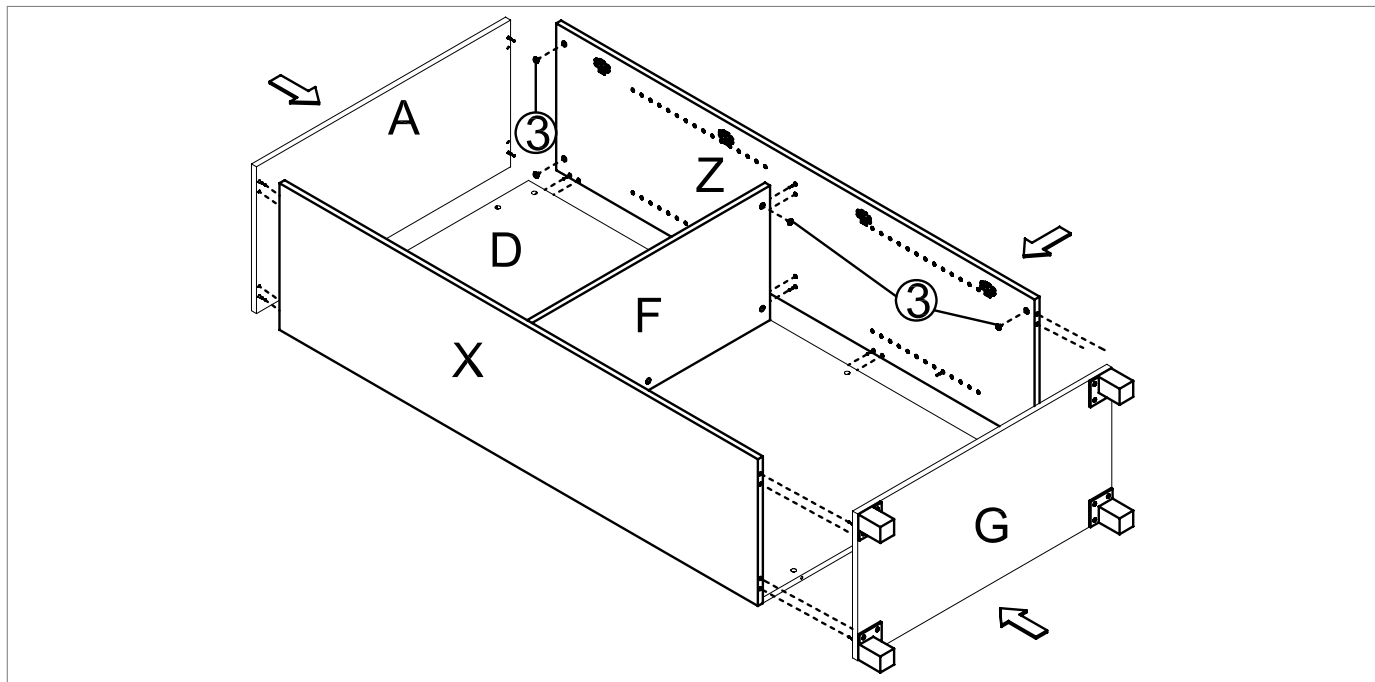

Step 4

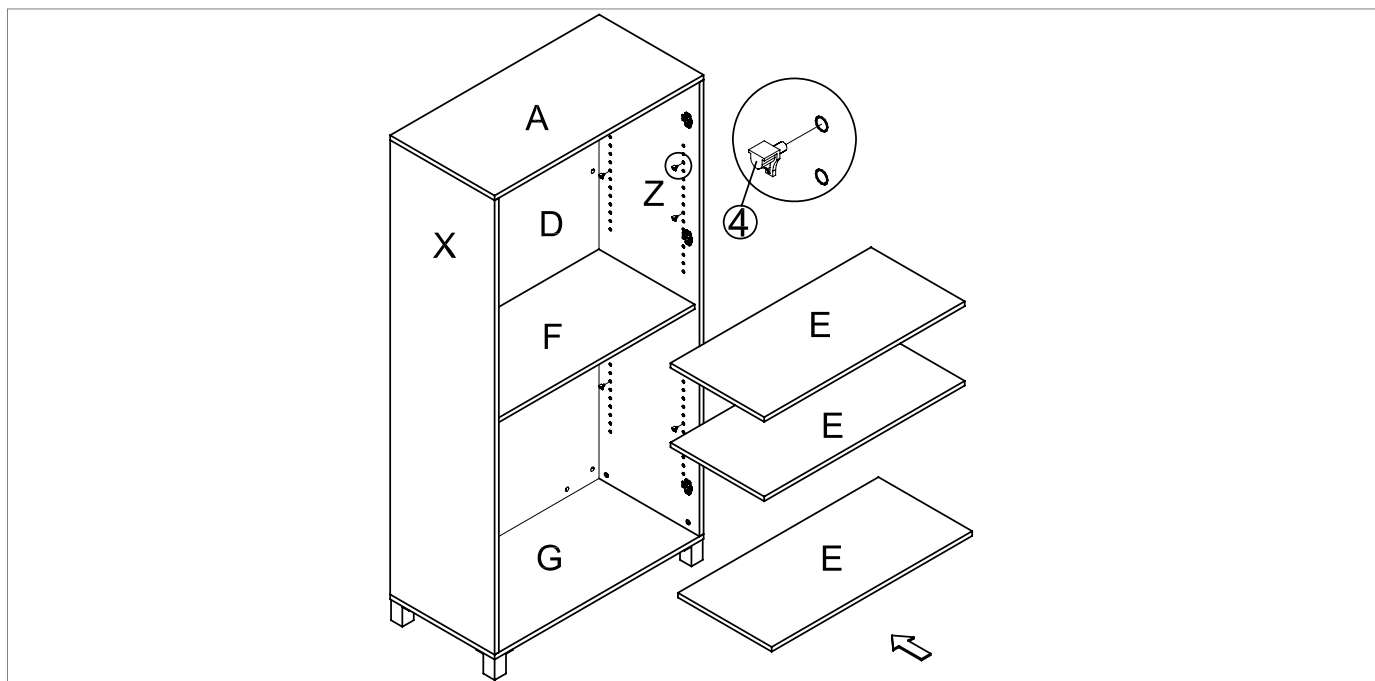

Assembly Instructions

Step 5

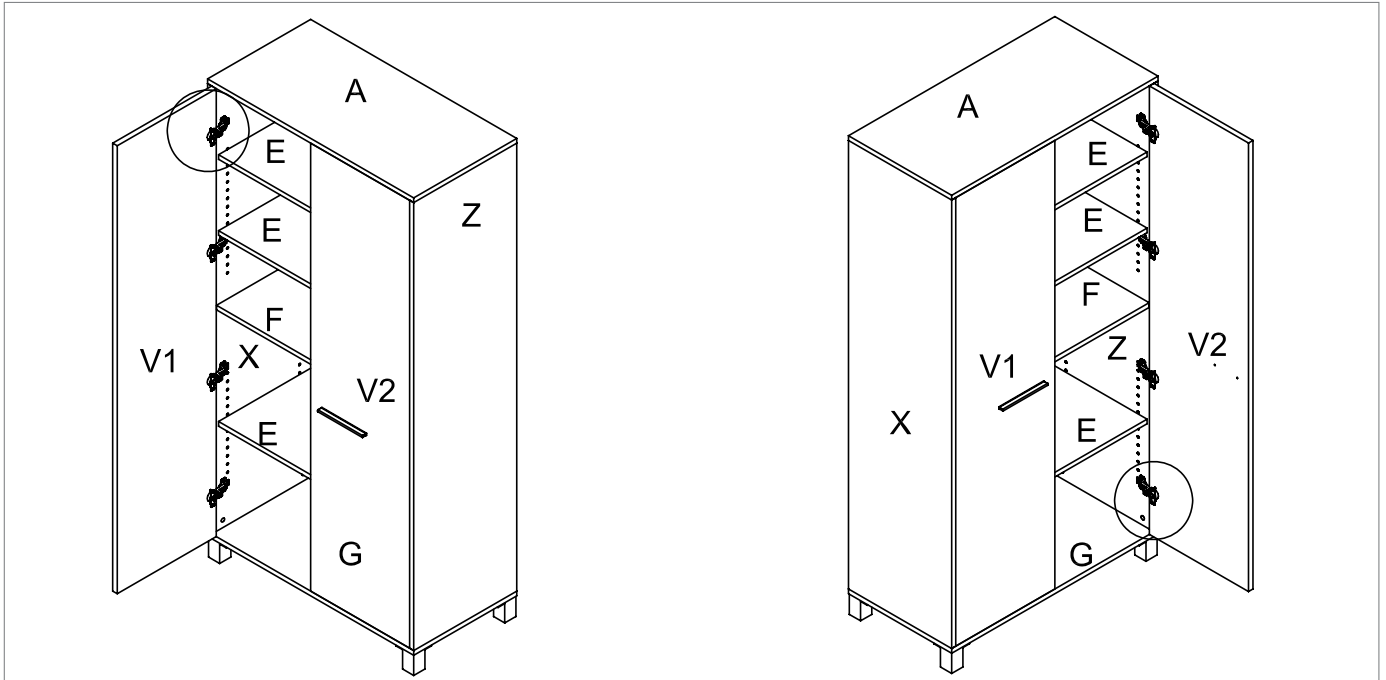

Step 6

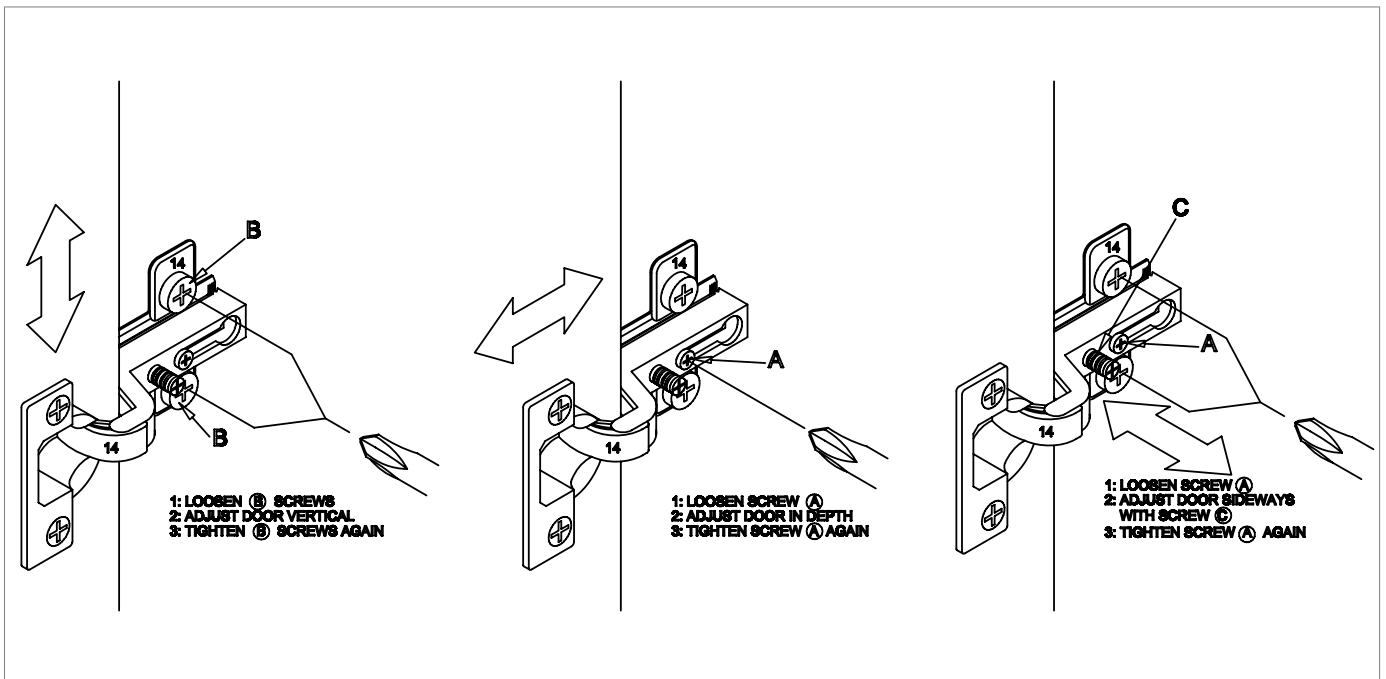

Assembly Instructions

Completed

