





Assembly Instructions
MODEL NO.:177524-1
 DESK MATE LH

1		2		3		4	
	Cam Lock 15pcs		Klix Cam 15pcs		Cam Cover 15pcs		Dowel 14pcs

STEP1

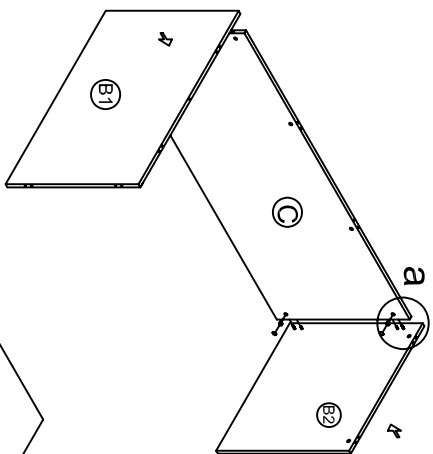

STEP2

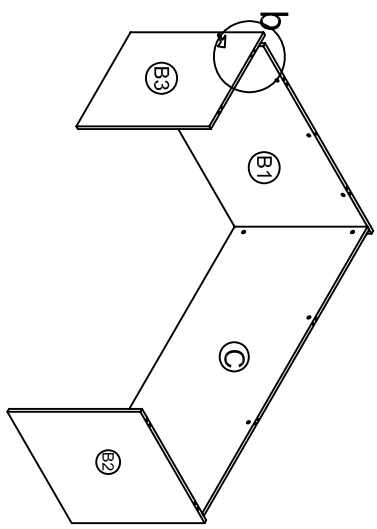

STEP3

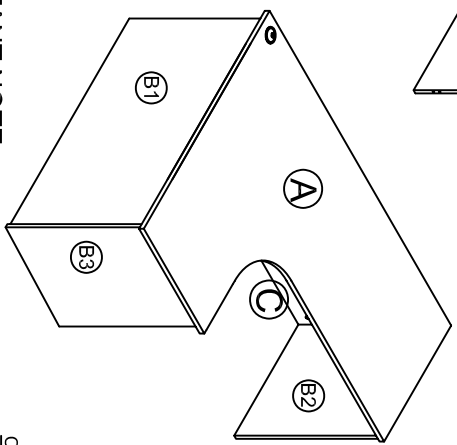
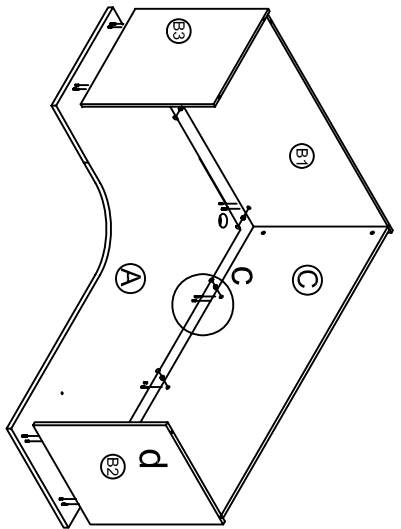

COMPLETED ASSEMBLY

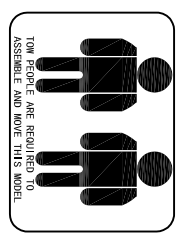
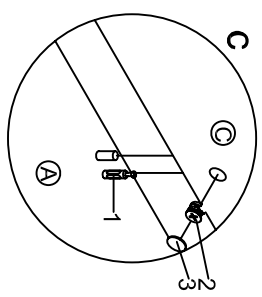
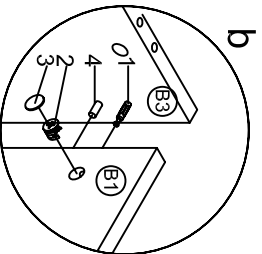
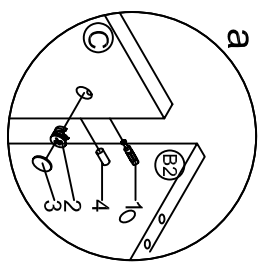

IMPORTANT:

FUNCTION OF KLIX CAM



1/4 RIGHT TURN FOR LOCKING

Make Sure The Arrow Is Pointing Upwards Before Inserting Into The Panel's Hole

IMPORTANT NOTE:

- Place all laminated parts on a clean and smooth surface such as a rug or carpet to avoid the parts from being scratched.
- Check to be sure that you have all parts and hardware.
- Remove all wrapping materials, including staples & packing straps before you start to assemble.
- Don't tighten all screws/bolts until all completely assembled.
- Keep all hardware parts out of reach of children